

**SYSTEM 2000**

SYSTEM 2000 SECTIONS

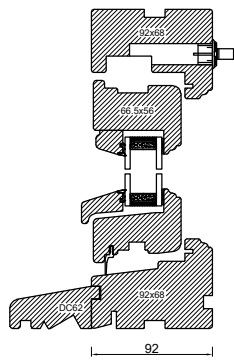

HEAD AND SOLE

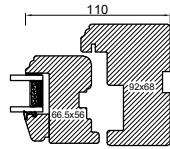

JAMB

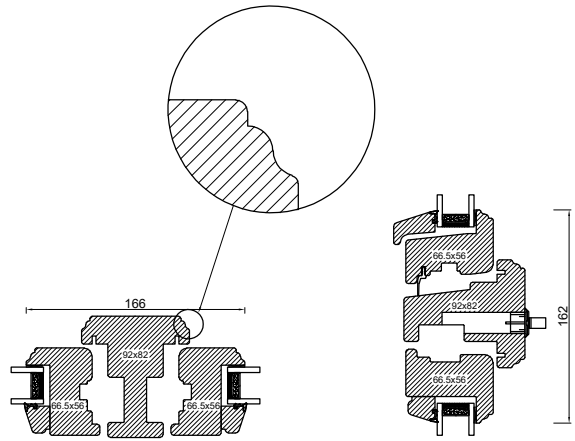

MULLION

TRANSOM

CILL EXTENSIONS

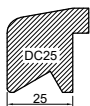

25MM CILL EXTENSION

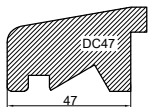

47MM CILL EXTENSION

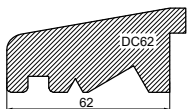

62MM CILL EXTENSION

BONDED BARS

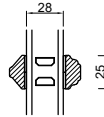

25MM BONDED BAR

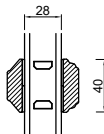

40MM BONDED BAR

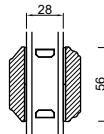

56MM BONDED BAR

BOTTOM BEADS

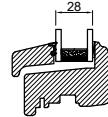

WOOD BOTTOM BEAD

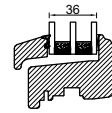

WOOD BOTTOM BEAD (TRIPLE GLAZED)

COUPLING

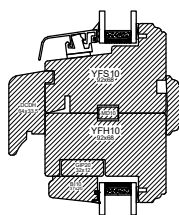

HORIZONTAL COUPLING

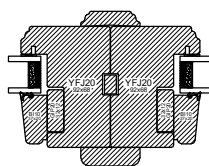

VERTICAL COUPLING

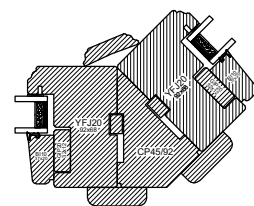

BAY COUPLING